

Bảng thông số sản phẩm

Thông số kỹ thuật



time delay relay 10 functions - 1 s..
100 h - 24..240 VAC - solid state
output

RE17LMBM

Main

Range of product	Harmony Timer Relays
product or component type	Modular timing relay
Discrete output type	Solid state
Width	17.5 mm
Component name	RE17L
time delay type	Power on-delay On-delay and off-delay Interval Off-delay Symmetrical flashing
time delay range	1...10 s 6...60 s 6...60 min 1...10 h 10...100 h 1...10 min 0.1...1 s
Nominal output current	0.7 A

Complementary

Control type	Selector switch front panel
[Us] rated supply voltage	24...240 V AC 50/60 Hz
Voltage range	0.85...1.1 Us
Supply frequency	50...60 Hz +/- 5 %
release of input voltage	8 V
control signal pulse width	0.05 s typical
Insulation resistance	100 MOhm at 500 V DC conforming to IEC 60664-1
[Uimp] rated impulse withstand voltage	5 kV during 1.2/50 µs
power on delay	100 ms
Connections - terminals	Screw terminals, 1 x 0.5...1 x 3.3 mm ² (AWG 20...AWG 12) solid without cable end Screw terminals, 2 x 0.5...2 x 2.5 mm ² (AWG 20...AWG 14) solid without cable end Screw terminals, 1 x 0.2...1 x 2.5 mm ² (AWG 24...AWG 14) flexible with cable end Screw terminals, 2 x 0.2...2 x 1.5 mm ² (AWG 24...AWG 16) flexible with cable end
Tightening torque	0.6...1 N.m conforming to IEC 60947-1
Dielectric strength	2.5 kV 1 mA/1 minute 50 Hz conforming to IEC 61812-1
Housing material	Self-extinguishing
Repeat accuracy	+/- 0.5 % conforming to IEC 61812-1

Temperature drift	+/- 0.05 %/°C
Voltage drift	+/- 0.2 %/V
Setting accuracy of time delay	+/- 10 % of full scale at 25 °C conforming to IEC 61812-1
Reset time	350 ms on de-energisation typical
On-load factor	100 %
Power consumption in VA	0...3 VA at 240 V AC
Maximum power consumption in W	1.5 W at 240 V DC
Breaking capacity	0.5 A AC conforming to UL 0.7 A AC at 20 °C
operating frequency	10 Hz
Maximum output current	20 A
Minimum switching current	10 mA
Maximum leakage current	5 mA
Maximum switching voltage	250 V AC
Maximum voltage drop	<4 V 3-wire <8 V 2-wire
Electrical durability	100000000 cycles
marking	CE
Creepage distance	4 kV/3 conforming to IEC 60664-1
Safety reliability data	MTTFd = 353.8 years B10d = 320000
Mounting position	Any position in relation to normal vertical mounting plane
Mounting support	35 mm DIN rail conforming to IEC 60715
Function available	A- Power on-delay relay-1 solid state output Ac- On-delay and off-delay relay w/ control signal-1 solid state output At- Power on-delay relay w/ pause/summation (Y1)-1 solid state output B- Single interval relay w/ control signal-1 solid state output Bw- Double interval relay w/ control signal-1 solid state output C- Off-delay relay w/ control signal-1 solid state output D- Symmetrical flashing relay (starting pulse-off)-1 solid state output Di- Symmetrical flashing relay (starting pulse-on)-1 solid state output H- Interval relay-1 solid state output Ht- Interval relay w/ pause/summation (Y1)-1 solid state output
Control type	Without test button
net weight	0.068 kg
Time delay type	A, Ac, At, B, Bw, C, D, Di, H, Ht
Functionality	Multifunction
Number of functions	10
Compatibility code	RE17

Environment

Immunity to microbreaks	20 ms
Derating factor	5 mA/°C

Standards	2004/108/EC IEC 61000-6-2 IEC 61812-1 IEC 61000-6-4 IEC 61000-6-1 2006/95/EC IEC 61000-6-3
Product certifications	GL cULus CSA
Ambient air temperature for storage	-30...60 °C
Ambient air temperature for operation	-20...60 °C
IP degree of protection	IP20 (terminal block) conforming to IEC 60529 IP40 (housing) conforming to IEC 60529 IP50 (front panel) conforming to IEC 60529
Vibration resistance	20 m/s ² (f= 10...150 Hz) conforming to IEC 60068-2-6
Shock resistance	15 gn for 11 ms conforming to IEC 60068-2-27
Relative humidity	93 % without condensation conforming to IEC 60068-2-30
Electromagnetic compatibility	Electrostatic discharge immunity test: (in contact), level 3, 6 kV, conforming to IEC 61000-4-2 Electrostatic discharge immunity test: (in air), level 3, 8 kV, conforming to IEC 61000-4-2 Susceptibility to electromagnetic fields: (80 MHz to 1 GHz), level 3, 10 V/m, conforming to IEC 61000-4-3 Electrical fast transient/burst immunity test: (capacitive connecting clip), level 3, 1 kV, conforming to IEC 61000-4-4 Electrical fast transient/burst immunity test: (direct), level 3, 2 kV, conforming to IEC 61000-4-4 1.2/50 µs shock waves immunity test: (differential mode), level 3, 1 kV, conforming to IEC 61000-4-5 1.2/50 µs shock waves immunity test: (common mode), level 3, 2 kV, conforming to IEC 61000-4-5 Conducted RF disturbances: (0.15...80 MHz), level 3, 10 V, conforming to IEC 61000-4-6 Voltage dips and interruptions immunity test: (1 cycle), 0 %, conforming to IEC 61000-4-11 Voltage dips and interruptions immunity test: (25/30 cycles), 70 %, conforming to IEC 61000-4-11 Conducted and radiated emissions: , class B, conforming to EN 55022

Packing Units

Unit Type of Package 1	PCE
Number of Units in Package 1	1
Package 1 Height	2.8 cm
Package 1 Width	7.8 cm
Package 1 Length	9.4 cm
Package 1 Weight	72.0 g
Unit Type of Package 2	S02
Number of Units in Package 2	40
Package 2 Height	15.0 cm
Package 2 Width	30.0 cm
Package 2 Length	40.0 cm
Package 2 Weight	3.222 kg

Bền vững

Nhãn **Green Premium™** là cam kết của Schneider Electric trong việc cung cấp sản phẩm với hiệu suất môi trường tốt nhất. Green Premium cam kết tuân thủ các quy định mới nhất, minh bạch về tác động môi trường, cũng như các sản phẩm tuần hoàn và CO₂ thấp.

Hướng dẫn đánh giá tính bền vững của sản phẩm là tài liệu kỹ thuật phổ thông giúp làm rõ các tiêu chuẩn nhãn sinh thái toàn cầu và cách diễn giải việc khai báo môi trường.

[Tìm hiểu thêm về Green Premium >](#)

[Hướng dẫn đánh giá về sự bền vững của sản phẩm >](#)



Minh bạch [RoHS/REACH](#)

Hiệu suất sức khỏe

Mercury Free

RoHS Exemption Information [Yes](#)

Chứng nhận & Tiêu chuẩn

Reach Regulation [REACH Declaration](#)

Eu RoHS Directive Pro-active compliance (Product out of EU RoHS legal scope)

China RoHS Regulation [China RoHS declaration](#)

Environmental Disclosure [Product Environmental Profile](#)

Circularity Profile [End of Life Information](#)

Bảng thông số sản phẩm

RE17LMBM

Dimensions Drawings

Width 17.5 mm

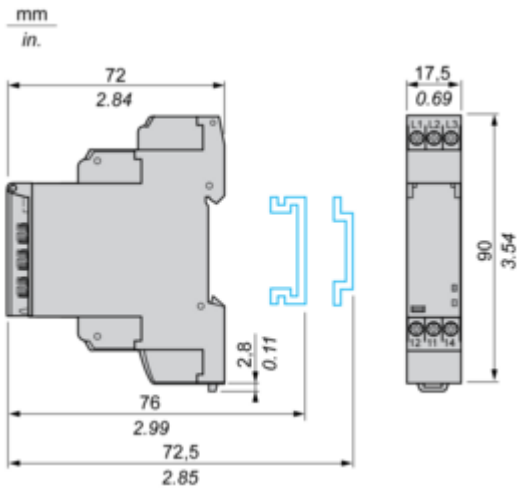

Connections and Schema

Internal Wiring Diagram

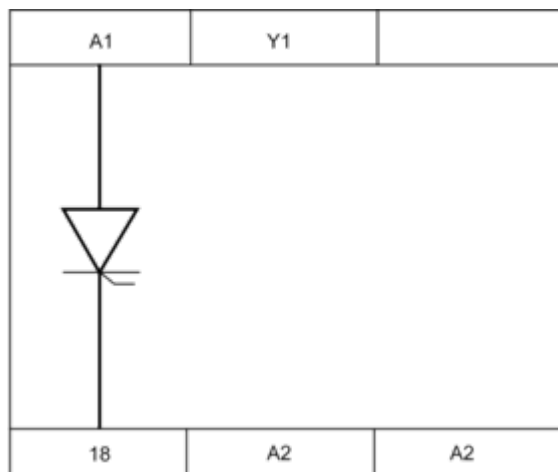

Wiring Diagram

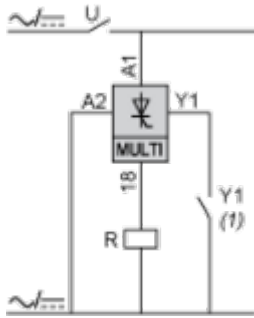

(1) Contact Y1:

- Control for functions B, C, Ac, Bw.
- Partial stop for functions At, Ht.
- Function D if Di selected.
- Not used for functions A and H.

Technical Description

Function A : Power on Delay Relay

Description

The timing period T begins on energisation. After timing, the output(s) R close(s). The second output can be either timed or instantaneous.

Function: 1 Output



Function: 2 Outputs

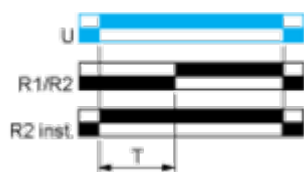

2 timed outputs (R1/R2) or 1 timed output (R1) and 1 instantaneous output (R2 inst.)

Function Ac: On-Delay & Off-Delay with Control Signal

Description

After energisation of power supply and energization of Y1 causes the timing period T to start.

At the end of this timing period, the output(s) R close(s).

When deenergization of Y1, the timing T starts.

At the end of this timing period T, the output(s) R revert(s) to its/their initial position.

The second output (R2) can be either timed (when set to "TIMED") or instantaneous (when set to "INST").

Function: 1 Output

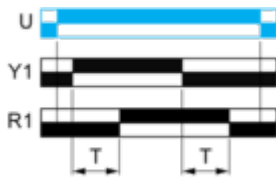

Function: 2 Outputs

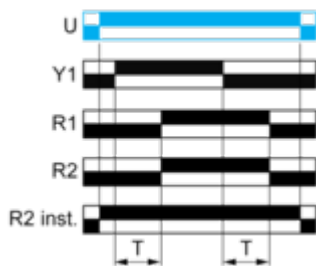

Function At : Power on Delay Relay (Summation) with Control Signal

Description

After power-up, the first opening of control contact C starts the timing. Timing can be interrupted each time control contact closes. When the cumulative total of time periods elapsed reaches the pre-set value T, the output relay closes.

Function: 1 Output

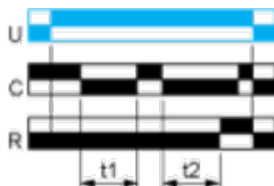

$$T = t1 + t2 + \dots$$

Function B : Interval Relay with Control Signal

Description

After power-up, pulsing or maintaining control contact C starts the timing T. The output R closes for the duration of the timing period T then reverts to its initial state.

Function: 1 Output

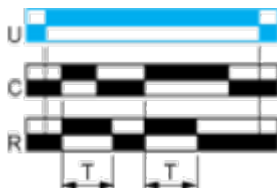

Function Bw : Double Interval Relay with Control Signal

Description

On closing and opening of control contact C, the output R closes for the duration of the timing period T.

Function: 1 Output



Function C : Off-Delay Relay with Control Signal

Description

After power-up and closing of the control contact C, the output R closes. When control contact C re-opens, timing T starts. At the end of the timing period, the output(s) R revert(s) to its/their initial state. The second output can be either timed or instantaneous.

Function: 1 Output

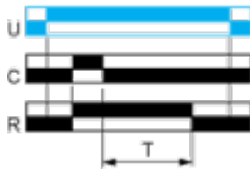

Function: 2 Outputs

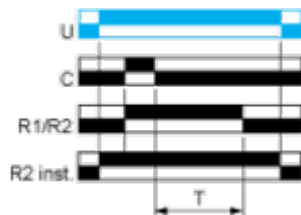

2 timed outputs (R1/R2) or 1 timed output (R1) and 1 instantaneous output (R2 inst.)

Function D: Symmetrical Flashing Relay (Starting Pulse Off)

Description

On energisation of power supply, output(s) R starts at its/their initial state for timing duration T then change(s) to output(s) R close(s) for the same timing duration T. This cycle is repeated indefinitely until power supply removal. Specially for RE17*, RE22R2AMU, RE22R2MMW, RE22R2MMU, RE22R2MJU, this D function can only be initiated by energizing Y1 permanently. The second output (R2) can be either timed (when set to "TIMED") or instantaneous (when set to "INST").

Function: 1 Output

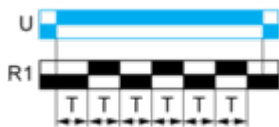

Function: 2 Outputs

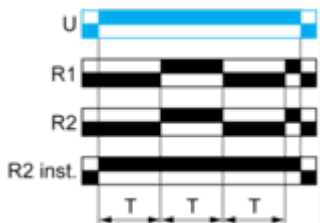

Function: 1 Output with Retrigger / Restart Control

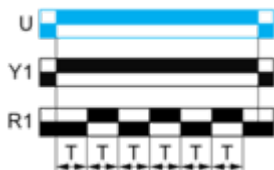

Function: 2 Output with Retrigger / Restart Control

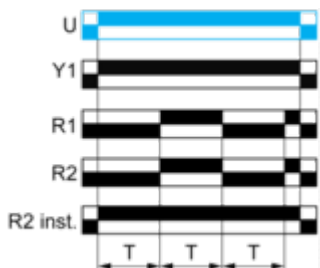

Function Di : Symmetrical Flasher Relay (Starting Pulse On)

Description

Repetitive cycle with two timing periods T of equal duration, with output(s) R changing state at the end of each timing period T .

The second output can be either timed or instantaneous.

Function: 1 Output



Function: 2 Outputs

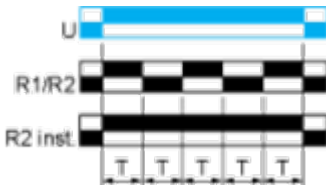

2 timed outputs (R1/R2) or 1 timed output (R1) and 1 instantaneous output (R2 inst.)

Function H : Interval Relay

Description

On energisation of the relay, timing period T starts and the output(s) R close(s). At the end of the timing period T, the output(s) R revert(s) to its/their initial state. The second output can be either timed or instantaneous.

Function: 1 Output



Function: 2 Outputs

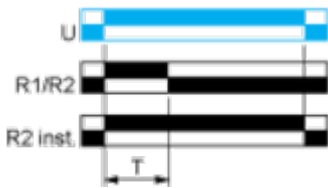

2 timed outputs (R1/R2) or 1 timed output (R1) and 1 instantaneous output (R2 inst.)

Function Ht: Interval Relay & With Pause / Summation Control

Description

On energisation of power supply, output(s) R close(s) and timing period T starts.

The timing can be interrupted / paused each time X1 energizes.

When the cumulative total of time periods elapsed reaches the pre-set value T, the output(s) R revert(s) to its/their initial state. Reenergization of X1 will also cause output(s) R close(s) if the time has elapsed and restart the same operation as described at the beginning.

Except for RE17*, RE22R2MMW, RENF22R2MMW, RE22R2MMU and RE22R2MJU, timing can be interrupted / paused each time Y1 energizes.

The second output (R2) can be either timed (when set to "TIMED" or instantaneous (when set to "INST").

Function: 1 Output

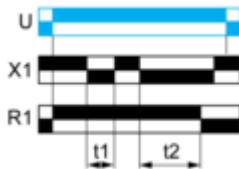

$$T = t1 + t2 + \dots$$

Function: 2 Outputs

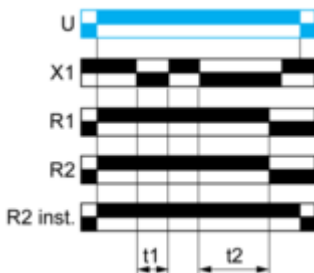

$$T = t1 + t2 + \dots$$

Function: 1 Output with Retrigger / Restart Control

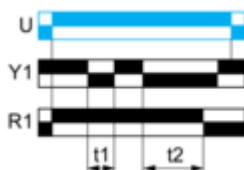



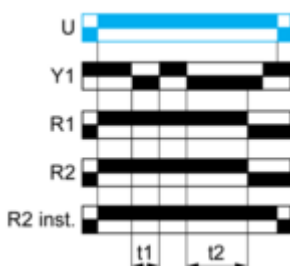

$$T = t1 + t2 + \dots$$

Function: 2 Outputs with Retrigger / Restart Control



$$T = t1 + t2 + \dots$$

Legend

	Relay de-energised
	Relay energised
	Output open
	Output closed

C	Control contact
G	Gate
R	Relay or solid state output
R1/R2	2 timed outputs
R2 inst.	The second output is instantaneous if the right position is selected
T	Timing period
Ta -	Adjustable On-delay
Tr -	Adjustable Off-delay
U	Supply